

TorchLED 2 Ex

Manual



VERSION	CHANGES
1.0	First edition
1.1	09.11.22 P.2 ATEX Number entered
1.2	02.05.23 P.6 New Art.No. 862000, P.8 Weight 182g
1.3	10.08.23 P.15 EU declaration of conformity adapted
1.4	30.10.23 New luminous flux, emergency light operating time
1.5	22.04.24 P.8-10 Adapted texts
1.6	07.08.24 P.15 EU declaration of conformity adapted

Contents

1	General information	3
1.1	Marking concept for hazards and hints	3
1.2	Responsibilities of the operator	3
2	Installation.....	4
2.1	General	4
2.2	Environmental	4
2.3	Electrostatic discharge	4
2.4	Charging of the TorchLED 2 Ex	5
2.5	Battery pack	5
2.6	Storage / cleaning	5
3	Product	6
3.1	Product marking	6
3.2	Special conditions for safe use	6
3.3	Risk	7
3.4	Application areas.....	7
3.5	Product characteristics and features	7
3.6	Scope of delivery.....	8
3.7	TorchLED 2 Ex technical data.....	8
3.8	Charging station technical data.....	9
3.9	Dimensions TorchLED Ex / universal charging station	10
4	Functional overview	11
4.1	Symbol explanations	11
4.2	Operating the basic functions.....	11
4.3	Charge status display.....	12
4.4	Emergency light function.....	12
5	Service and troubleshooting.....	13
5.1	Batteries	13
5.2	Inspection and maintenance	14
5.3	Troubleshooting	14
5.4	Repair.....	14
6	EU-Declaration of Conformity	15
7	Service.....	16
7.1	Service addresses.....	16
7.2	Imprint	16
7.3	Disposing of the device	16

1 General information

1.1 Marking concept for hazards and hints

Hazard

Hazardous situation which will cause serious injury or even death if it is not prevented.

Caution

Hazardous situation which could cause slight to moderate injury if it is not prevented.

Hint

Indicates information which does not concern personal injury, e.g. hints in respect of material damage.

Protective measures

Increase safety by applying a protective measure.

1.2 Responsibilities of the operator

1. Ensure that this document is always in a legible form and stored with the device.
2. Read this instruction manual carefully and thoroughly before operating the device for the first time.
3. This product has been developed and manufactured exclusively for the application specified within this document. Any application not explicitly stated in this document could damage the integrity of the product and/or be a source of danger.
4. The manufacturer will reject any liability for damage caused by any improper use of the product.
5. Countries that are not part of the European Community must observe national legal regulations, as well as any other valid standards and provisions, in order to guarantee a corresponding level of safety.
6. The installation of the TorchLED 2 Ex charging station must be carried out in accordance with the applicable regulations.
7. The manufacturer will not accept any liability in the event of incorrect installation or any deformations that may occur as a result.
8. The electric power supply must be switched off before any interventions on the TorchLED 2 Ex charging station.
9. Only original parts from the manufacturer may be used for maintenance. Only qualified personnel may carry out maintenance work on the TorchLED 2 Ex torch light.
10. Any procedure that is not explicitly included in the instructions by the manufacturer is not permitted.
11. The packaging material must not be kept within the reach of children; this is a potential source of danger.

Indication

If the TorchLED 2 Ex is used in harsh or hazardous environments, the housing must be kept close to avoid damage and malfunctions.

It should also be ensured that the TorchLED 2 Ex charging station is used in a place protected from humidity and wetness.

2 Installation

2.1 General

The TorchLED 2 Ex is a microcontroller controlled Intrinsically Safe light.

Components:

- Main board with 2 power LEDs + one signal LED where the PCB acts as the heat sink.
- Battery board which contains 2 Li-Po cells connected in parallel and which provides the charging circuitry, battery protector and Intrinsically Safe current and power limiter circuits. The battery pack is not user replaceable. Charging only occurs in the safe area.

The TorchLED 2 Ex is only chargeable from the universal charger that contains protective circuitry and has been assessed in accordance with EN-IEC-60079-11.

2.2 Environmental

Always follow local regulations and at least IEC60079-14 (Explosive atmospheres - Part 14: Electrical installations design, selection and erection) or other local codes of practice.

Charging may only take place in the safe area using the Gifas universal charger. Use of any other charger will invalidate the Intrinsically Safe protection of the TorchLED 2 Ex. The universal charger may only be used indoors, in a clean and dry location.

The allowed temperature range during charging must be 0 °C ... +40 °C.

Discharging and storage may be any Zone 1 or Zone 21 or safer location in accordance with the marking and IEC60079-14, in particular with the rated ambient temperature range Ta.

The TorchLED 2 Ex may not be allowed to build up dust, appropriate sanitary measures need to be taken to prevent this.

Even though the TorchLED 2 Ex may be allowed to be used at temperatures below 0 °C , please be aware that the battery capacity may be substantially reduced, possibly even by 50%.

When the TorchLED 2 Ex battery is completely empty it is highly recommended to remove it from the hazardous area and to place the TorchLED 2 Ex in the universal charger as soon as possible.

It should also be noted that protective circuits in the TorchLED 2 Ex remain active at all time, even when the device appears to be turned off. These circuits will slowly drain the TorchLED 2 Ex until battery protection circuits completely shut off the battery.

2.3 Electrostatic discharge

The TorchLED 2 Ex surface has examined to be safe when there is a risk of electrostatic discharges during the intended use.

Care must be taken not to use the TorchLED 2 Ex in an environment with a prolific charge generating mechanism that can affect the TorchLED 2 Ex.

Examples where not to use the TorchLED 2 Ex:

- Areas where a pneumatic transfer of powders occur.
- Areas where charge spraying in a powder coating process occurs.

Created 27.09.2022 chal	Modified 07.08.2024 chal	Object-ID 3178402
--------------------------------------	---------------------------------------	-----------------------------

2.4 Charging of the TorchLED 2 Ex

The TorchLED 2 Ex is only chargeable from the Gifas universal charger that contains protective circuitry and has been assessed in accordance with EN-IEC-60079-11.

- Observe an ambient temperature $0\text{ }^{\circ}\text{C} < T_a < +40\text{ }^{\circ}\text{C}$ during charging
- The TorchLED 2 standby time exceeds 1 year, but it is highly recommend to check the battery at regular intervals as draining the battery below 2V will cause permanent degradation of the cells and reduce battery life.
- When the TorchLED 2 has been automatically shut down due to a low battery voltage (2.8V) it should be recharged as soon as possible, as further self-discharge of the cells below 2V will cause permanent degradation of the cells and reduce battery life.
- Reviving LiPo cells that have been discharged below 2V is not recommended and will void your warranty. When in doubt contact your reseller.
- The universal charger can be powered from 12V-48VDC batteries and provides the required protected voltage to the charger circuit on the Battery board.
- The universal charger can also be powered from a 230V mains adapter that provides a SELV (double isolated) DC voltage according to IEC-61558-2-6 or IEC-61010-1 of less than 50V.
- Do not attempt to charge the TorchLED 2 Ex from an ordinary TorchLED 2 charger.
- The universal charger is able to detect either a non-Ex TorchLED 2 or a TorchLED 2 Ex by the presence of a magnet and delivers the required voltage and polarity.
- In the hazardous area the charging contacts are protected by Intrinsically Safe circuits to prevent ignition capability. It is recommended to not unnecessarily touch these contacts to prevent electrostatic discharges that might damage the charging circuitry.
- Internally the battery pack is permanently connected to the TorchLED 2 Ex main board. Do not touch any of the circuits. Do not disassemble. The battery pack is not user replaceable.

2.5 Battery pack

The battery pack of the TorchLED 2 Ex should be able to receive 1.000 charges. At this time the capacity may be reduced by 20% of the original capacity. As other factors can further reduce battery capacity it is recommended to have the battery pack replaced when noticeable capacity reduction has occurred.

2.6 Storage / cleaning

No additional measures are required for storage. Ensure that the packaging will not be damaged. When soiled, clean the light with a cleaning cloth. Do not use scouring / abrasive agents or solvents!

3 Product

3.1 Product marking

The following labels are attached to the explosion-safe TorchLED 2 Ex:



Figur 1: Outside label



Figur 2: Inside label

The TorchLED 2 Ex is CE marked according to European ATEX directive 2014/34/EU:

II 2 G Ex ib IIC T4 Gb

II 2 D Ex ib IIIC T140°C Db

This means the TorchLED 2 Ex is designed for use in industrial applications and it fulfils the requirements of product category 2 for use in hazardous areas due to the presence of explosive mixtures of gases, mists, vapors or dust in air. The TorchLED 2 Ex is suitable for use in hazardous areas classified as zone 1, 21, 2 and 22. The applied method of protection is Intrinsic Safety and gas group IIC and dust group IIIC are applicable. The temperature class with regard to the ignition of gas is T4. The maximum surface temperature with respect to the ignition of dust is 140 °C.

Compliance with the Essential Health and Safety requirements has been assured by compliance with EN 60079-0:2012 / A11:2013 (General requirements) and EN 60079-11:2012 (Intrinsic safety).

The ambient / operational temperature is $-20\text{ °C} < T_a < +45\text{ °C}$.

The ATEX certificate number is KIWA 16ATEX0046X. The X behind the certificate number indicates that special conditions for safe use as given below are applicable.

3.2 Special conditions for safe use

- Charging of the TorchLED 2 Ex in an hazardous area is not allowed
- Only the following original Gifas Electric TorchLED Ex universal chargers are allowed:
 - TorchLED 2 Ex universal battery charger 230 VAC, Gifas article No. 860998
 - TorchLED 2 Ex universal battery charger 12 - 48 VDC, Gifas article No. 860999
 - The maximum prospective short circuit current at the connection point of the universal charger to the power source shall be $\leq 300\text{ A}$.

3.3 Risk

Attention

The bundled light can damage the eyes under certain circumstances.

Protective measures

Do not look directly at the LED from a short distance without taking the necessary protective measures. Protective goggles with tinted lenses are recommended as a protective measure.

3.4 Application areas

The TorchLED 2 Ex is a modern work and inspection light with a wide range of use:

- Work and inspection light for maintenance purposes
- Field lamp for civil protection or the military
- Private use

Thanks to state-of-the-art LED technology, the TorchLED 2 Ex is extremely energy-efficient.

Indication

The TorchLED 2 Ex universal charging station is suitable for installation on construction materials of normal flammability. The TorchLED 2 Ex operating temperature range is -20 °C to 45 °C.

3.5 Product characteristics and features

The basic characteristics and advantages of the TorchLED 2 Ex are:

- robust housing with elastomer-encapsulated grips
- slip-resistant / impact-resistant
- free-standing
- low weight
- attachment strap / clip for carrying strap
- various operation modes
- memory function = last setting is retained
- gold-plated charging pint

3.6 Scope of delivery



Figur 3: TorchLED 2 Ex



Figur 4: charging station

3.7 TorchLED 2 Ex technical data

Power supply:	3,7 V Lithium Polymer battery, 1.440 mAh
Charging time full battery capacity:	approx. 5 h
Light duration 2 LEDs:	approx. 3,5 h (see chapter 4 for further information)
Light:	2 Power-LED
Luminous flux 2 LEDs:	215 lm
LED charge status display:	green
Light color:	cool white, 5'000 K
LED service life:	> 50,000 h
Degree of protection:	IP54 (closed housing)
Protection class:	III
Temperature range:	- use: -20 °C to +45 °C - charge: 0 °C to +40 °C
Dimensions (H x W x D):	116 x 68 x 34 mm
Weight :	182 g

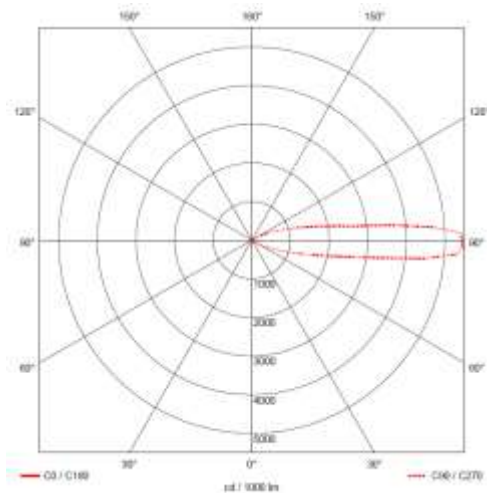

Figur 3: Spotlight beam characteristics

3.8 Charging station technical data

Operating voltage:	12 - 48 VDC 100 - 240 VAC 50/60 Hz
Charging characteristics:	6,2 V, 320 mA (TorchLED 2 Ex, reversed polarity) 9,1 V, 780 mA (non-Ex TorchLED 2)
Housing:	ABS
Weight:	110 g / 180 g
Degree of protection:	IP44
Protection class:	II
Contacts:	spring steel, gold-plated
Temperature range:	0 °C to +40 °C
Dimensions (H x W x D):	80 x 87 x 44 mm
Installation type:	installation against the wall

i Indication

When the batteries have been completely drained, there will briefly be no display when the light is being re-charged in the charging station, even though it is actually charging!

The display appears as soon as the batteries are charged over the threshold voltage; this is not a malfunction of the TorchLED Ex or the charging unit.

The temperature range for charging the batteries is 0 °C to 40 °C. The batteries must not be charged at temperatures outside this range.

3.9 Dimensions TorchLED Ex / universal charging station



Figur 4: TorchLED 2 Ex dimensions

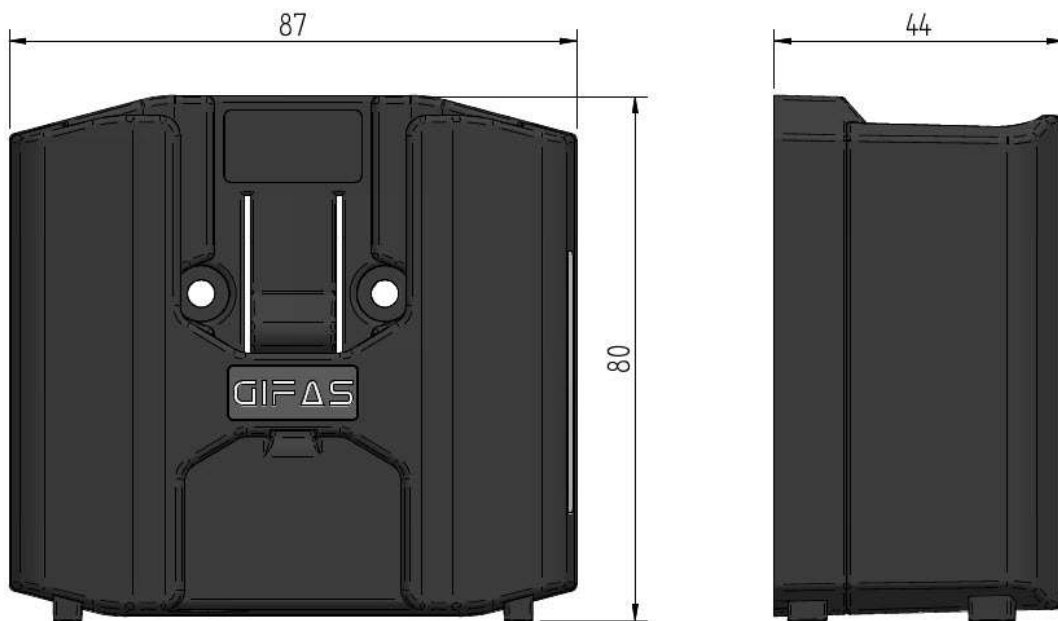



Figur 5: Universal charger dimensions

4 Functional overview



4.1 Symbol explanations







Button functions		
Symbol	Function	Symbol
	On / off	Tapping: Switches the light on and off The memory function becomes active each time the light is switched on (last selected setting).
	Function selection or dimming	Quick actuation: Function selection: Broad light, focused light or full light Long actuation while switched-on: Dimming

Light functions		
Main function	Function	Light duration at 20 °C
1 x Power LED	Broad or focused light (full power)	approx. 7 h
	Broad or focused light (dimmed)	> 48 h
2 x Power LED	Full power	approx. 3,5 h
	Dimmed	> 24 h
1 x Power LED	Emergency light (broad light)	approx. 7 h

4.2 Operating the basic functions

Switching the light on:	A quick actuation of  switches on the light according to the most last setting.
Lighting mode selection:	A quick actuation of  switches the operating mode.

Dimming:	A one-time long actuation of  reduces the brightness of the light. Another long actuation of  increases the brightness of the light.
Switching the light off:	A quick actuation of  when the light is switched on will switch it off again.
Emergency light:	A three second actuation of  and  while the light is in the universal charger toggles the emergency light mode.

4.3 Charge status display

Charge status display:

Emergency light function is on:

battery charging: green status led blinks 1,1 sec on and 0,1 sec off

battery charged: green status led blinks 0,1 sec on and 1,1 sec off

Emergency light function is off:

battery charging: green status led blinks 0,6 sec on and 0,6 sec off

battery charged: green status led is on without blinking.

Batteries:

If the battery charge goes below approx. 20%, this will be the TorchLED 2 Ex signaled by the light blinking twice which will be repeated every two minutes.

At the same time, the light will enter the energy saving mode and it is dimmed to 25% of its maximum power.

The remaining light duration depends on the mode and dimming level.

The light must be recharged as soon as possible in order to avoid damaging the batteries.

4.4 Emergency light function

If the emergency light function is activated and power-loss occurs during charging of the TorchLED 2 Ex, the upper (wide) LED of the TorchLED 2 Ex will be switched on at full power.

The energy saving mode will not be activated during emergency light mode; the light will remain at full power until the batteries are empty.

As soon as power to the TorchLED 2 Ex is restored, the light is turned off again and the charging operation is continued.

When the emergency light mode is on, the mode key is ignored and the power button can be used to turn the light off. The emergency light can be switched off by pressing the button .

5 Service and troubleshooting

5.1 Batteries

In order to guarantee flawless operation, the following rules for the handling of batteries apply:

Self-discharge:

The self-discharge of the unused batteries is very minor. It is not linear and depends on various parameters, such as temperature, charge status, batteries status etc.

📌 Indication

The batteries should be recharged every 6 months.

Service life:

Up to 1.000 charge cycles are possible if the batteries is well looked-after. The batteries should NEVER be deep-discharged!

📌 Indication

It is best to recharge the batteries after every use.

Charging:

The batteries are not charged outside the following temperature range: 0°C to 40°C

📌 Indication

Always charge the batteries at room temperature.

Storage:

Temperatures above 40°C and excessive humidity damage batteries.

📌 Indication

Always store batteries at room temperature and keep them dry.

Guarantee:

Batteries are classified as wearing parts. They can be damaged by improper use and as a result, their service life can be significantly impaired. Because of this, the batteries does not have the same guarantee period as the device itself.

📌 Indication

Light: 2 years. Batteries: 1 year

Observing the points above will not stop the ageing process, but will slow it down significantly.

Created 27.09.2022 chal	Modified 07.08.2024 chal	Object-ID 3178402
--------------------------------------	---------------------------------------	-----------------------------

5.2 Inspection and maintenance

The requirements as stated in EN-IEC 60079-17 or other codes of practice valid on the place of installation apply.

If the TorchLED 2 Ex enclosure or LED window appears cracked, dented, broken or otherwise no longer in good condition or are very dirty they must be immediately repaired or cleaned.

As the device internal circuits are always on, in case of damage it must be removed from the hazardous area immediately and may only be restored after the repair has been carried out and approved.

After approximately 1000 charges or when a noticeable capacity reduction occurs it is recommended to have the battery pack replaced.

The cycle of maintenance depends on the specific conditions of use. As a general guide line for light use a 12 month interval is recommended.

All functions of this light are to be serviced in accordance with the relevant regulations, standards and rules of the respective country and revised by professionally trained personnel when required.

5.3 Troubleshooting

Fault/error message	Possible cause(s)	Remedy
TorchLED 2 Ex can no longer be charged	Charging station defective	Contact GIFAS, replace charging station if necessary
TorchLED 2 Ex can no longer be charged, but charging station still works	Charging electronics or batteries defective	Contact GIFAS, send back torch light for repair (replace the batteries)
An LED no longer illuminates	LED defective	Contact GIFAS, send back torch light for repair
The light illuminates for a short time only, despite being charged	Batteries are no longer functional	Contact GIFAS, send back torch light for repair (replace the batteries)

5.4 Repair

Repair to the TorchLED 2 Ex may only be done by using original parts. It shall be carried out by qualified skilled workers who have been trained in accordance with EN-IEC 60079-19 or other codes of practice valid on the place of installation.

Applying of non-original parts may lead to injury to persons and damage to equipment.

If non-original parts are used or repair has been carried out in an incompetent manner the warranties concerning explosion safety no longer apply. Therefore it is necessary to return the equipment to the manufacturer in cases repair is demanded.

6 EU-Declaration of Conformity

EU-KONFORMITÄTSERKLÄRUNG / EU-DECLARATION OF CONFORMITY / DECLARATION UE DE CONFORMITE

Wir / We / Nous: **GIFAS-ELECTRIC GmbH, CH-9424 Rheineck**

erklären in alleiniger Verantwortung, dass das nachfolgend aufgeführte Produkt aufgrund seiner Bestückung und Bauart in der von uns in Verkehr gebrachten Ausführung den einschlägigen Sicherheits- und Gesundheitsanforderungen der EU-Richtlinie entspricht. Bei einer nicht mit uns abgestimmten Änderung des Produkts verliert diese Erklärung ihre Gültigkeit.

declare under our sole responsibility that the product listed below, due to its configuration and type of construction as we put the execution into circulation of the appropriate security and health requested, correspond with the European guideline. Any change on the product without our agreement has the consequence, that the declaration will lose its validity.

déclarons sous notre seule responsabilité que le produit sousmentionné correspond aux exigences de sécurité et de santé des lignes d'application CE, en raison de son équipement et son genre de construction. Cette déclaration perd sa validité lors de modification du produit sans notre accord.

Produkt:	Explosiongeschützte Akku Handleuchte	
Product:	Explosion-safe battery hand lamp	
Produit:	Lampe de poche accu anti-déflagrant	
Typ/Type/Type:	TorchLED 2 Ex	
EU-Richtlinien:	ATEX Herstellerrichtlinie 2014/34/EU EMV Richtlinie 2014/30/EU	
EC-Guidelines:	ATEX Directive 2014/34/EU EMC Guideline 2014/30/EU	
Directives de la CE:	Directive ATEX 2014/34/UE Directive CEM 2014/30/UE	
Angewandte Normen/ Applied standards/ Normes:	EN IEC 60079-0:2018 EN 60079-11:2012 EN IEC 55015:2019+A1:2020 IEC 60598-2-8:2013	EN 61000-6-2:2019 EN 61547:2009 EN IEC 61000-3-2:2019+A1 IEC 62471:2006

Zertifizierungsstelle : Eurofins Electric & Electronic Product testing AG, 8320 Fehraltorf, Switzerland
EG-Baumusterprüfbescheinigungsnummer: SEV 22 ATEX 0644X
Überwachende Stelle: Eurofins Electric & Electronic Product testing AG, 8320 Fehraltorf, Switzerland
Überwachungsnummer: QAN SEV 16 ATEX 4161

CH-9424 Rheineck, 07.08.2024

GIFAS-ELECTRIC GmbH



Y. Rödiger, Geschäftsführer
Y. Rödiger, Managing Director
Y. Rödiger, Président-directeur général

Created 27.09.2022 chal	Modified 07.08.2024 chal	Object-ID 3178402
--------------------------------------	---------------------------------------	-----------------------------

7 Service

7.1 Service addresses

GIFAS ELECTRIC GmbH Borsigstrasse 9 D-41469 Neuss	GIFAS-ELECTRIC S.r.l Via dei Filaracci 45 Piano del Quercione I-55054 Massarosa (LU)	GIFAS ELECTRIC GmbH Strass 2 A-5301 Eugendorf	GIFAS-ELECTRIC GmbH Dietrichstrasse 2 Postfach 275 CH-9424 Rheineck
☎ +49 2137 105-0 📠 +49 2137 105-230 🌐 www.gifas.de ✉ verkauf@gifas.de	☎ +39 58 497 82 11 📠 +39 58 493 99 24 🌐 www.gifas.it ✉ info@gifas.it	☎ +43 6225 7191-0 📠 +43 6225 7191-561 🌐 www.gifas.at ✉ verkauf@gifas.at	☎ +41 71 886 44 44 📠 +41 71 886 44 49 🌐 www.gifas.ch ✉ info@gifas.ch

7.2 Imprint

GIFAS-ELECTRIC GmbH
CH-9424 Rheineck
www.gifas.ch

Technical changes and errors reserved.

These installation instructions are the property of GIFAS-ELECTRIC GmbH and may not be copied, translated, transferred, duplicated or passed on to third parties without the previous written consent of GIFAS-ELECTRIC.

7.3 Disposing of the device



This product must not be thrown in the garbage.

In accordance with official local and national regulations, this product is to be recycled appropriately.



European directive 2012/19/EU; waste electrical and electronic equipment (WEEE).